



Sanyo Cadnica N-3000CR Specifications

Sanyo battery charger specification sheet

1

--

•

Bookmarks

Quick Links

[Download this manual](#)

[Enlarged version](#)

Typical Characteristics

Charge (5 cells pack)

8.0
7.5
60
7.0
40
20
0
0
10
20
30

SANYO Cadnica

Charge Time (Mins)

Cell Capacity (at various discharge rate)

100
90
80
70
60
50
40
0
1
2
3

Discharge Rate (10)

Discharge (at low rate)

1.4

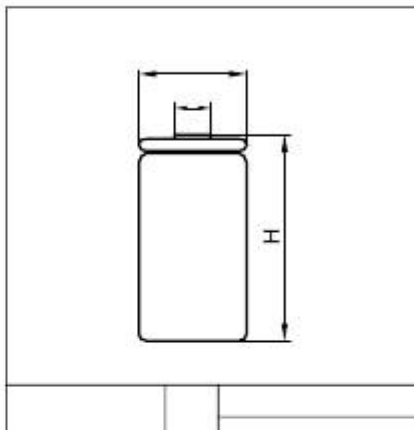

Charge Time (Mins)		Cell Capacity (at various discharge rate)	
Discharge Rate (10)	Discharge (at low rate)	Discharge Rate (10)	Discharge (at low rate)
8.0		100	
7.5		90	
60		80	
7.0		70	
40		60	
20		50	
0		40	
0		0	
10		1	
20		2	
30		3	

1.2
1.0
0.8
(0.5 lt)
(0.2 lt)
0
2
4
6

SANYO

Cadnica

Discharge Time (Hrs.)

D

d

49.0

±0.3

mm

H

±0.012

1.929

inch

Dimensions

±0.3

mm

25.2

of

D

±0.012

inch

0.992

Bare Cell

10.0

mm

d

0.394

inch

Charge : 4.5A to 45°C/113°F

70

40

50

60

Charge : 4.5A to 45°C/113°F

Discharge : End Volt 1.0V

at 20°C/68°F

4

5

6

7

Charge : 4.5A to 45°C/113°F

at 20°C/68°F

(0.1 lt)

8

10

12

14

16

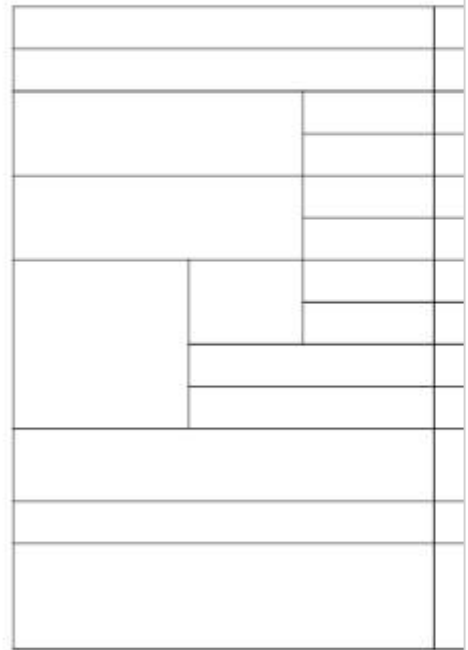
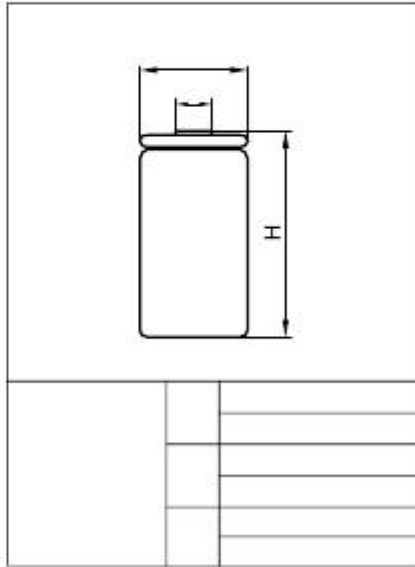
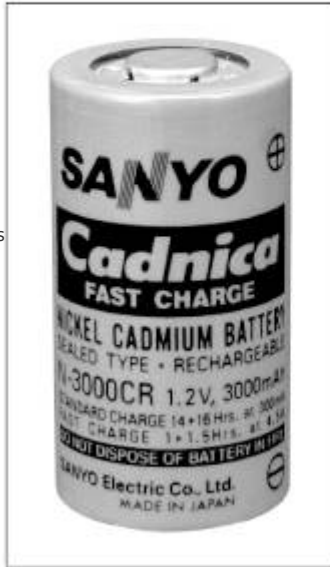

Charge : 4.5A to 45°C/113°F

Discharge : End Volt 1.0V

at 20°C/68°F

4

5

6

Charge : 4.5A to 45°C/113°F

at 20°C/68°F

(0.1 lt)

8

10

12

14

16

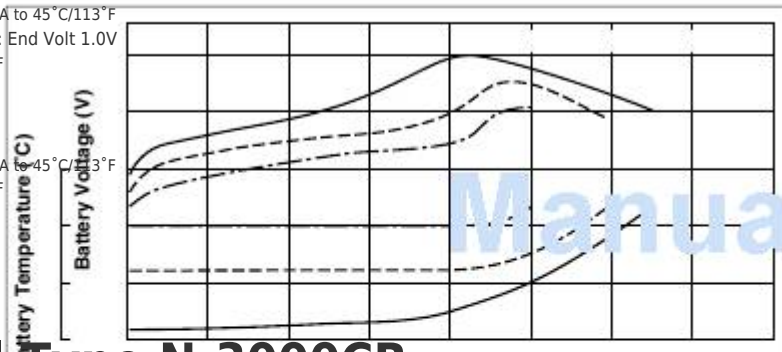

Cell Type N-3000CR

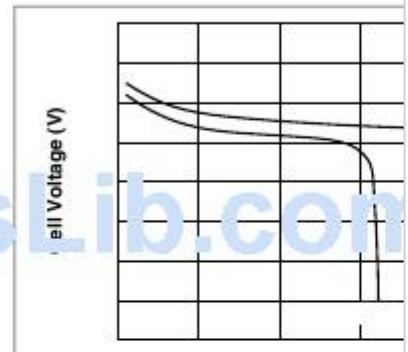

Specifications

Nominal Capacity

Nominal Voltage

Charging Current

Charging Time

Charge

Ambient

Temperature

Discharge

Storage

Internal Impedance (Av.)

(at 50% discharge)

Weight

Dimensions(D)×(H)

(with tube)

Discharge (at high rate)

1.4

1.2

1.0

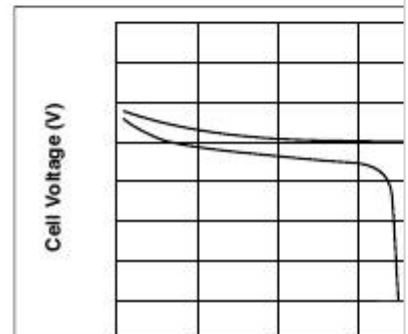
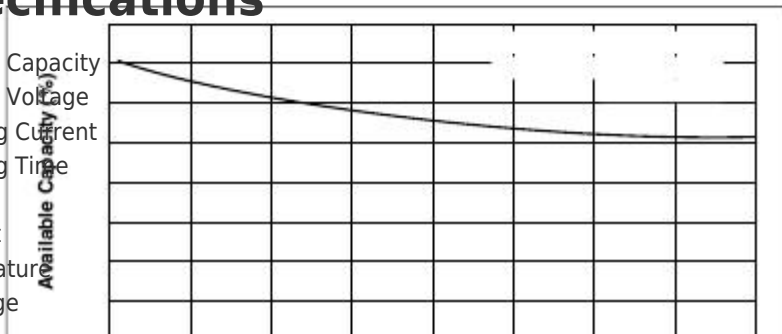

Discharge (at high rate)

1.4

1.2

1.0

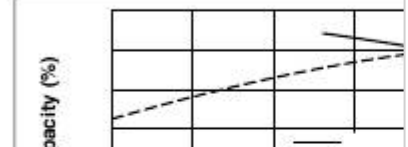
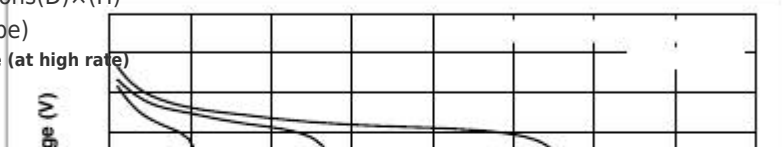

SANYO

Cadnica

0.8
80
0
10
1.4
1.2
1.0
0.8
0
2
8

Discharge (at high rate)

Temperature (Charge & Discharge)
100
90
80
70
60
50
40
-20
-10
-4
14
3000mAh
1.2V
Standard
300mA
Fast
4500mA
Standard
14 to 16Hrs.
Fast

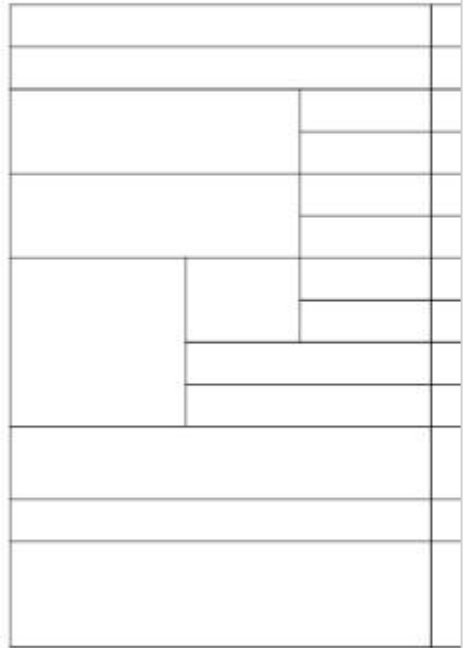
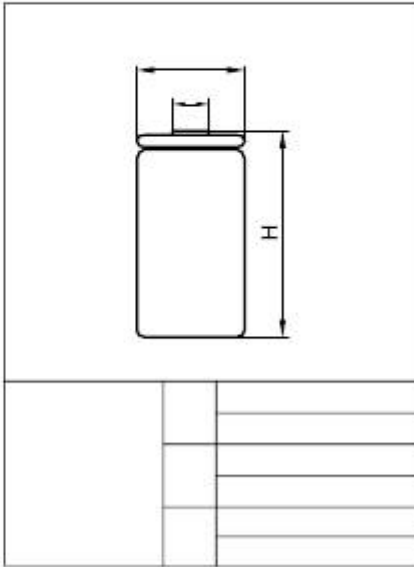
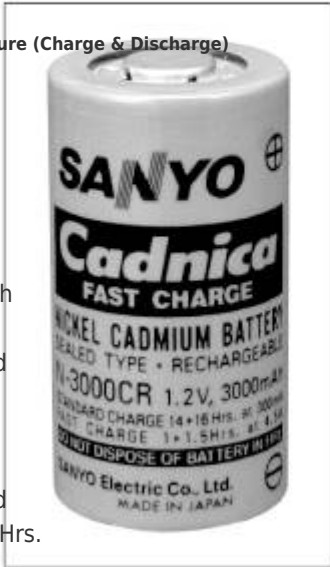

about 1Hr.
Standard
0°C to +45°C [+32°F to 113°F]

Fast
5°C to +40°C [+41°F to 104°F]
-20°C to +60°C [-4°F to 140°F]
-30°C to +50°C [-22°F to 122°F]

3.4mΩ
(at 1000Hz)
84g/2.96oz
× 50.0
26.0
-0.8
× 1.97
0
1.02

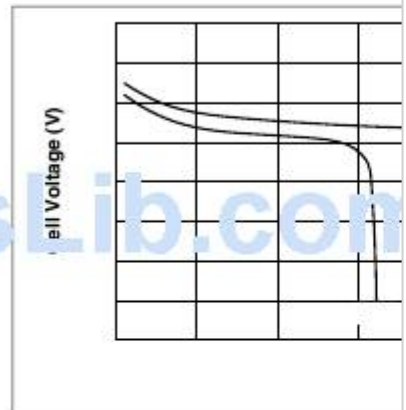
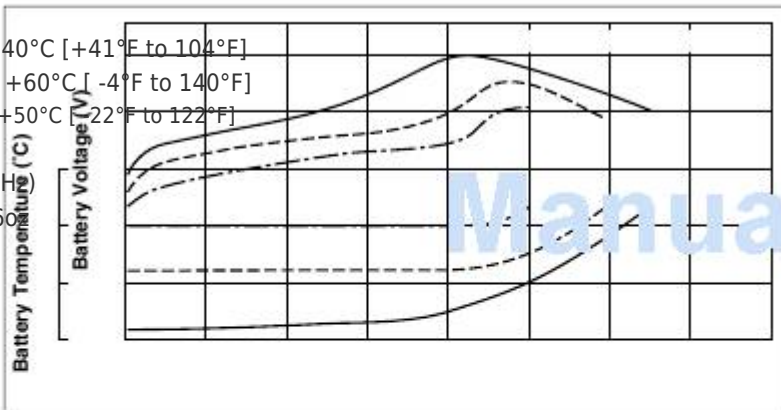

Charge : 4.5A to 45°C/113°F

(2 It)
20
30
40
50
60

Discharge Time (Mins)
Charge : 4.5A to 45°C/113°F
(8 It)

4
6
8
10
12

Discharge Time (Mins)

Charge Characteristics
Discharge Characteristics
Condition Charge : 4.5A to 45°C/113°F

Discharge : 600mA
(End Volt 1.0V)

0
10
20
30
40
50
68

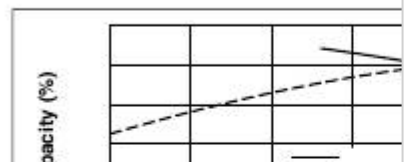
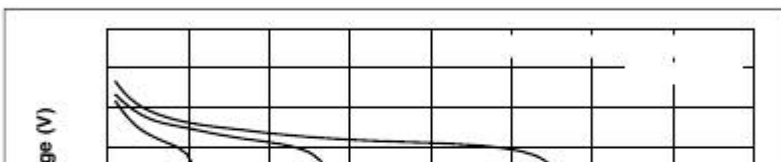
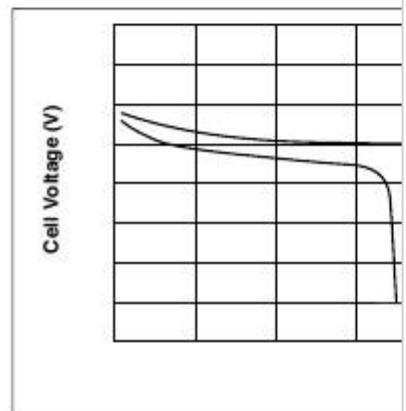
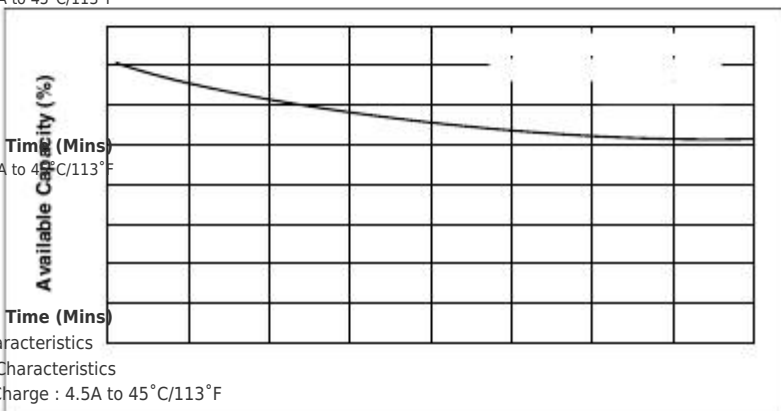

86
104
Operating Temperature
0
mm
-1.2
0
inch
-0.05
at 20°C/68°F
(1 lt)
70
80
at 20°C/68°F
(4 lt)
14
16
50
60°C
122
140°F
CD010830

SANYO

Cadnica

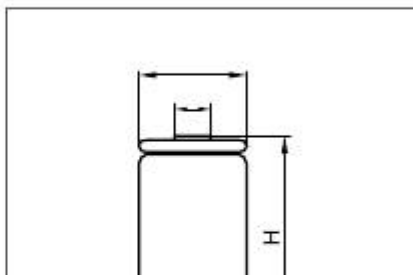

Related Manuals for Sanyo Cadnica N-3000CR

[Camera Accessories Sanyo Cadnica N-3U Specifications](#)

Sanyo battery charger specification sheet (1 page)

[Camera Accessories Sanyo Cadnica N-3US Specifications](#)

Sanyo cadnica specification sheet (1 page)

[Camera Accessories Sanyo SEB-013SEB-013 Brochure & Specs](#)

Sanyo lithium batteries (16 pages)

[Camera Accessories Sanyo N-270AA Cadnica Specifications](#)

Sanyo battery charger specification sheet (1 page)

[Camera Accessories Sanyo Cadnica KR-600AAL Specifications](#)

Sanyo battery specification sheet (1 page)

[Camera Accessories Sanyo CR17335 Specifications](#)

Sanyo lithium specification sheet (1 page)

[Camera Accessories Sanyo N-1250SCRL Cadnica Specifications](#)

Sanyo battery charger specification sheet (1 page)

[Camera Accessories Sanyo N-100AAS Cadnica Specifications](#)

Sanyo battery charger specification sheet (1 page)

[Camera Accessories Sanyo HR-AAC Specifications](#)

Sanyo digital camera battery specification sheet (1 page)

[Camera Accessories Sanyo UR18650A Datasheet](#)

Safety data sheet for chemical products (5 pages)

[Camera Accessories Sanyo Lithium ion Brochure & Specs](#)

Sanyo rechargeable batteries brochure (8 pages)

[Camera Accessories Sanyo CR17335HE-R Specifications](#)

Sanyo lithium product manual (1 page)

[Camera Accessories Sanyo CR14250SE Specifications](#)

Sanyo lithium specification sheet (1 page)

[Camera Accessories Sanyo UR18500F Specifications](#)

Lithium ion (1 page)

[Camera Accessories Sanyo Cadnica KR-1200SCL Specifications](#)

Sanyo cadnica specification sheet (1 page)

[Camera Accessories Sanyo UF103450P Specifications](#)

Lithium ion 1700mah 3.7V 1700mAh (1 page)